

## TeZ - Bioreactor workshop [2022]

<https://git.desearch.cc/TeZ/BIOREACT>

### What is a bioreactor?

A bioreactor is a **container which is used to hold organisms** for the purpose of harnessing their natural biochemical processes.

A simple and well known example of a bioreactor is a fermentation tank for beer, in which certain microorganisms are encouraged to thrive, causing the contents of the tank to ferment and creating a usable end product.

There are a number of types of bioreactors, and they are used for a variety of purposes, from processing solid waste to manufacturing pharmaceuticals.

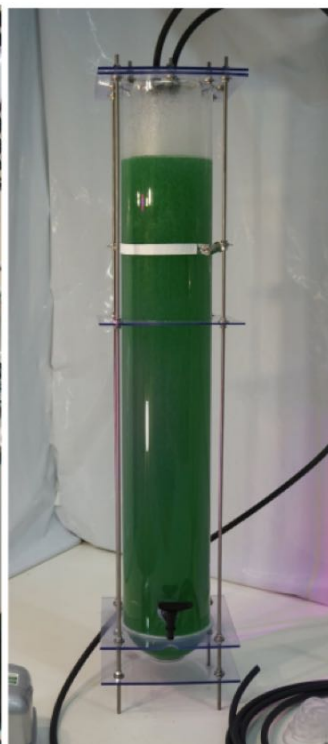
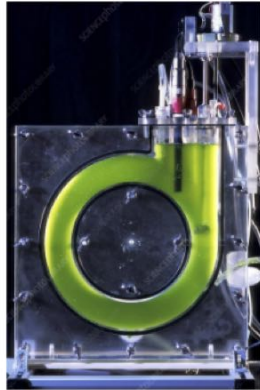

## Why a bioreactor?

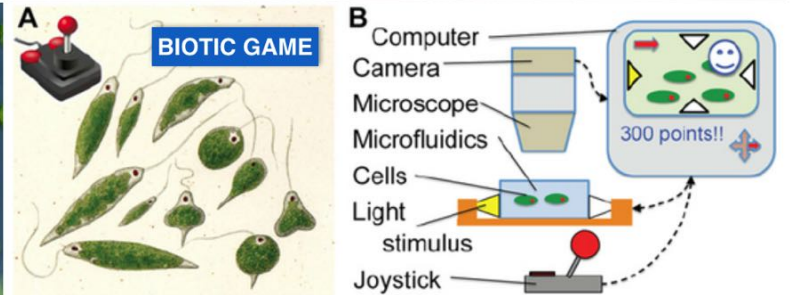
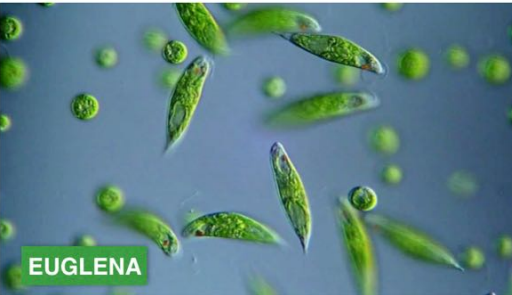
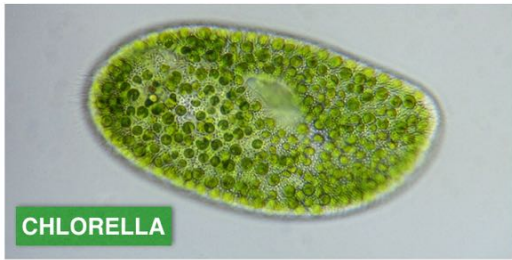

Some species of algae produce 50% or more lipids (oils) through a photosynthetic process. These oils can be extracted from large algae farms to produce biofuels like biodiesel, biogasoline, and biojetfuel, as well as plastics, adhesives, and cosmetics. They can even be used for products such as protein pills, pharmaceuticals, and feed for livestock. Algae-based biofuels are being considered as a substitute for fossil fuels.

## Euglena gracilis, Living

Item #: 152800 ★★★★★ 5.0 (3) [Description](#) [Specifications](#) [Reviews](#) [Q&A](#)

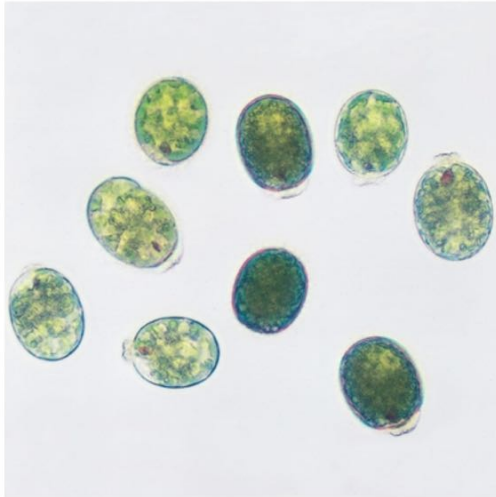

\$8.95

**!** [This product contains shipping or purchase restrictions. Read >](#)

Product: (in stock)

Quantity

- 1 + [Add to Cart](#)

[Add to Wishlist](#)

## EUGLENA MEDIUM RECIPE



1 full spoon  
skimmed milk

15 grains  
of rice

20 grains  
of wheat

- Mix all the ingredients with 1/2 liter of DISTILLED WATER
- Bring to boil for 10 minutes
- Let it sink until really cold (overnight)
- Filter out the grains and save in glass container

# EUGLENA

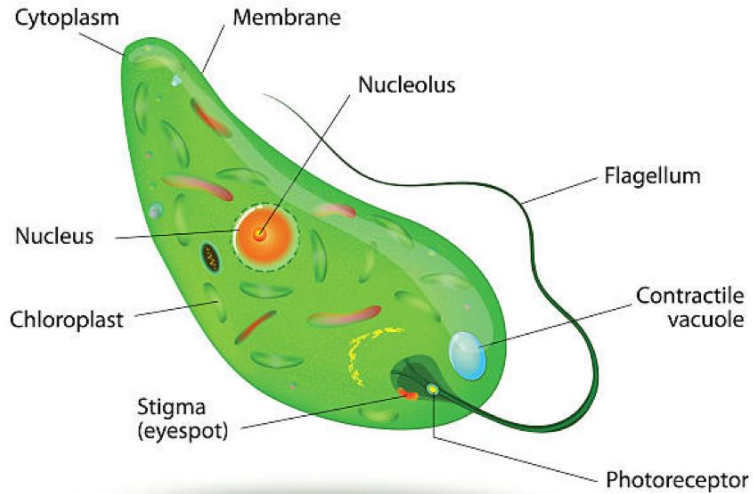

*Euglena gracilis*. This culture requires a **low light level** (50 to 100 foot-candles of fluorescent light or fluorescent light from the ceiling).

Optimal medium: Soil-Water (item #153785) + Pea.

**Optimum growth temperature: 22° C.**



**DIAGRAM OF STIRRED TANK BIOREACTOR**

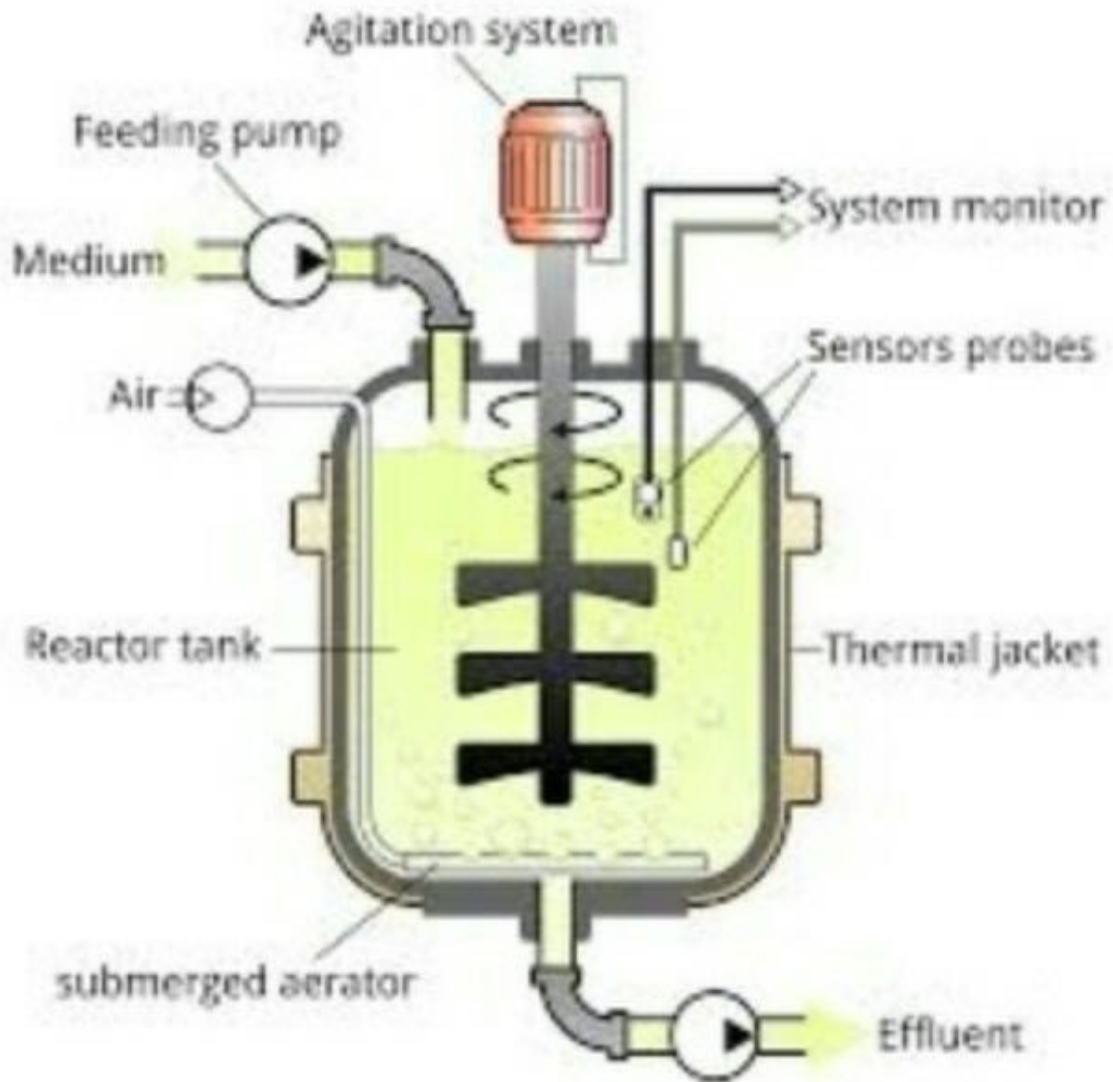

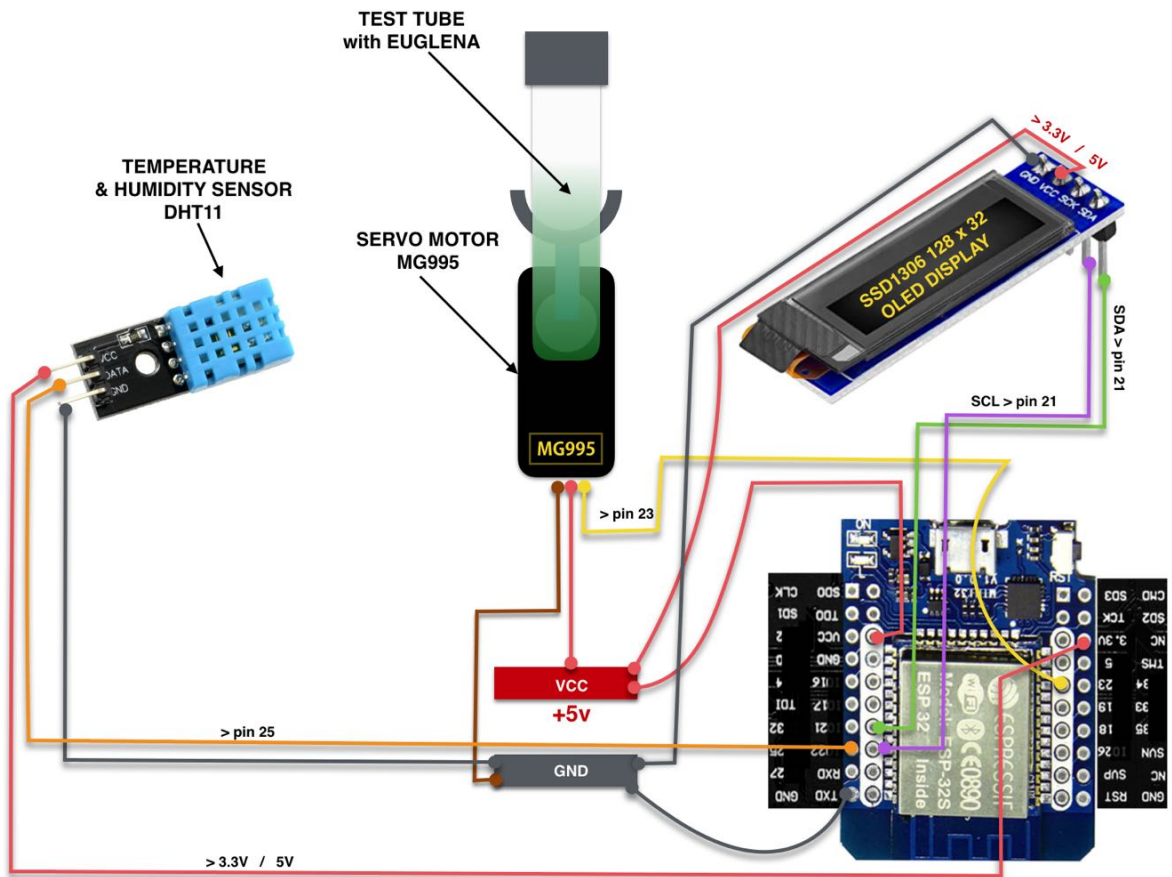

**DHT11 Ratings**

Parameters	Value	Units
Supply voltage	3 to 5.5	V
Supply current	0.5 to 2.5	mA
Sampling interval	1	sec

SSD1306 OLED DISPLAY  
power: 3.3V-5V

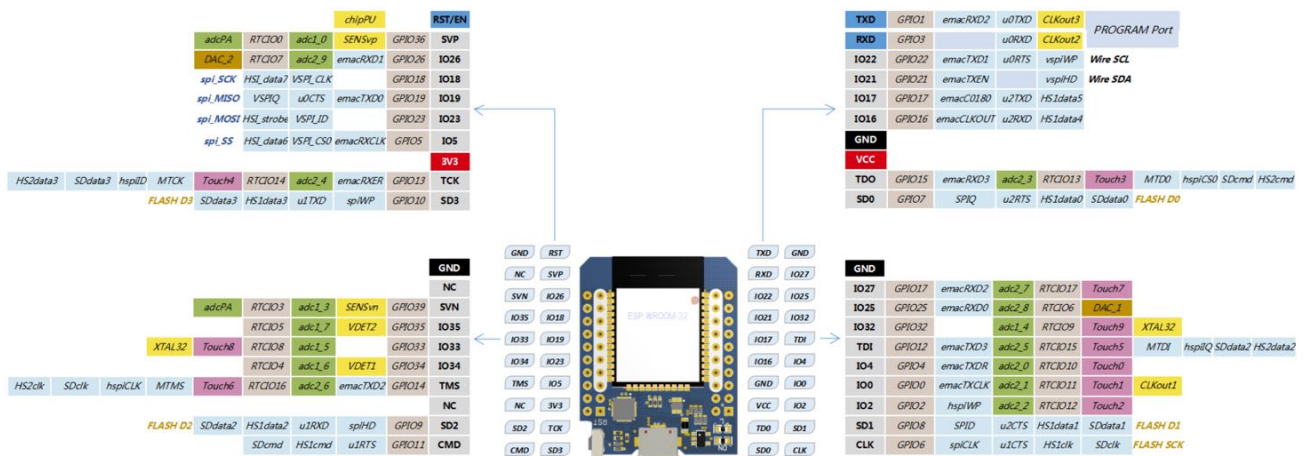

## ARDUINO CODE FOR ESP32

=====

```
// SIMPLE SERVO TEST
```

```
#include <ESP32Servo.h>
```

```
Servo myservo; // create servo object to control a servo
```

```
// Recommended PWM GPIO pins on the ESP32 include 2,4,12-19,21-23,25-27,32-33
```

```
int servoPin = 23;
```

```
void setup() {  
  myservo.setPeriodHertz(50);  
  myservo.attach(servoPin);  
}
```

```
void loop() {  
  myservo.write(0);  
  delay(2000);  
  myservo.write(180);  
  delay(2000);  
}
```

=====